

# LAMP® 3670 SOFT-CLOSE SLIDE Installation Manual



Thank you for selecting our product. Before starting installation, please read this manual thoroughly to ensure correct installation. Please keep this manual at hand for future reference.

## ABOUT THE PRODUCT

- Side mount drawer slide with soft-closing mechanism.
- The drawer is detachable by pulling the lever.

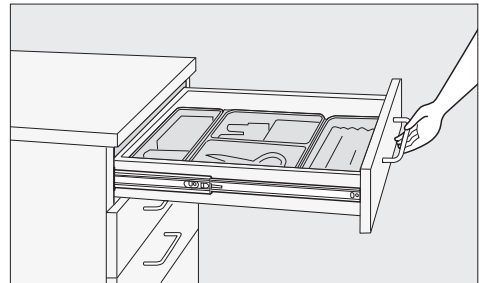

## DIMENSIONS, SPECIFICATIONS

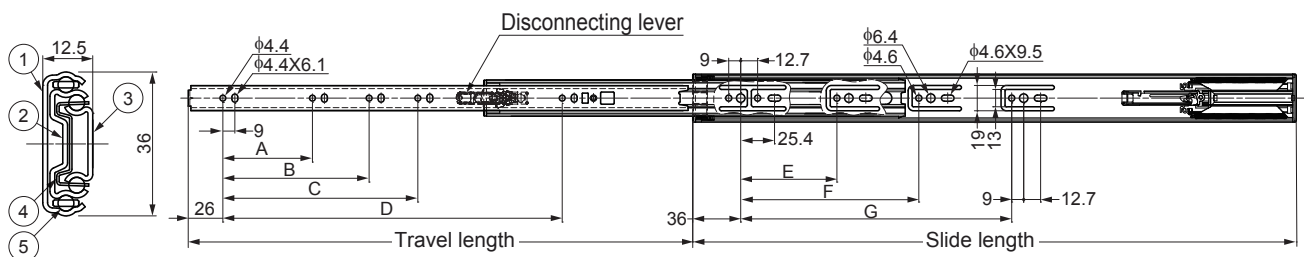

No.	Part name
①	Outer member
②	Intermediate member
③	Inner member
④	Retainer
⑤	Balls

● Non-handed

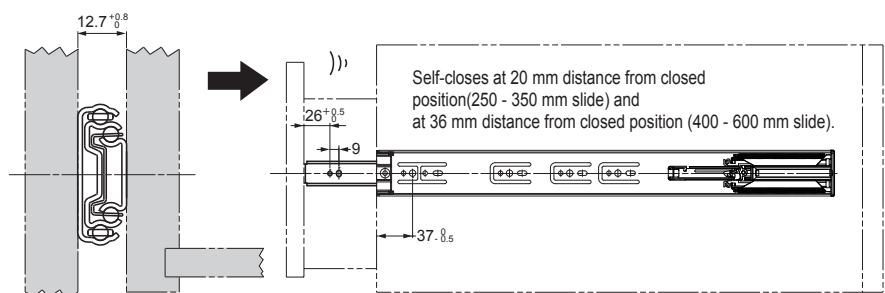

Item number	slide length	Travel length	A	B	C	D	E	F	G	Max. drawer width	Load capacity N(kgf)/pair	Box
3670-250	250	200	124	-	-	-	87	-	-	450	147(15)	20set
3670-300	300	300	174	-	-	-	-	-	500			
3670-350	350	350	96	224	-	-	-	-	550			
3670-400	400	400	160	256	-	-	119	199	-	600	196(20)	10set
3670-450	450	450	96	192	306	-		247	-	650		
3670-500	500	500	128	224	356	-		215	295	700		
3670-550	550	550			352	406			215	345		
3670-600	600	600			384	456		247	375	800		

## 1 Detaching slides

Pull out inner member until it stops, then pull the disconnect lever to detach.

How to detach

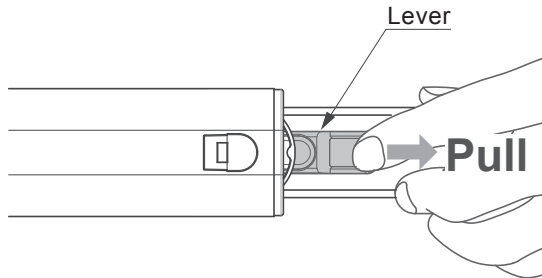

### ⚠ Caution

- ⊘ This product combines the inner member and outer member with high-precision mating, so do not change the combination.

## 2 Positioning / mounting Outer Member

Correct installation is necessary to enjoy push-to-open function. Mount the slides and make adjustments as follows.

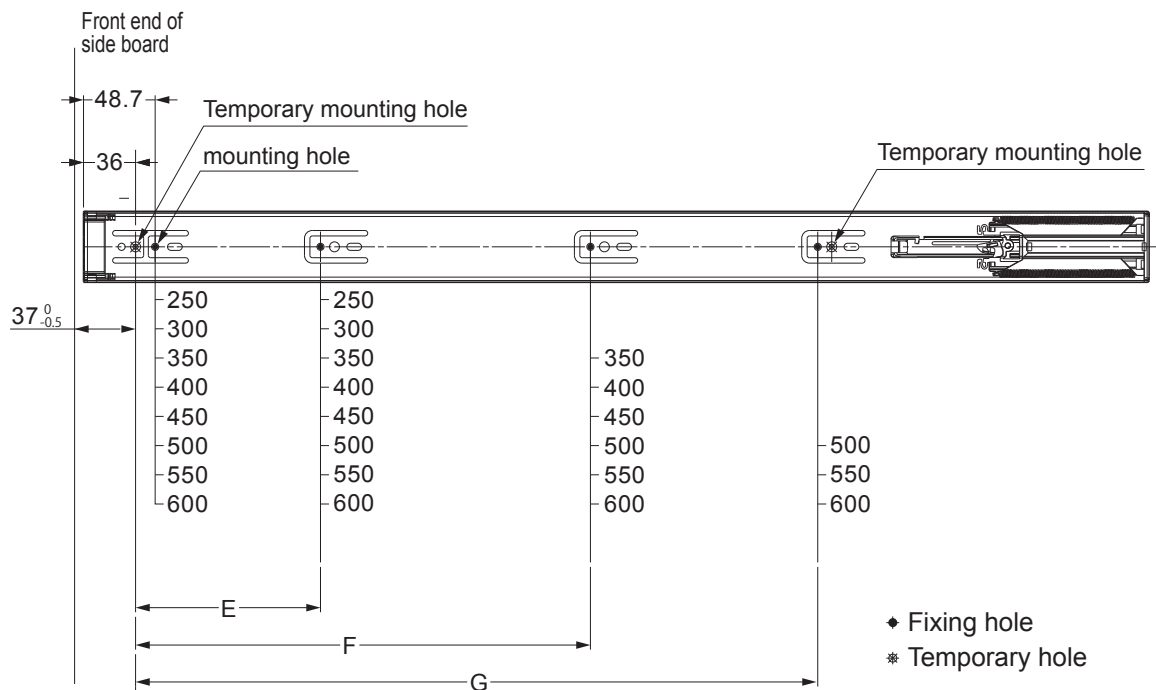

**[1]** Mark the positions of the slides on the inside of the cabinet and fit using the temporary mounting holes to give a little bit of adjustment.

**[2]** Do not fully tighten the screws just yet. Level up and fix using the round holes and tighten all screws.

Notes:

- Move the intermediate member to screw the holes through the access holes.
- Refer to page 1 about the dimensions E, F, and G.

### 3 Positioning / mounting Inner Member

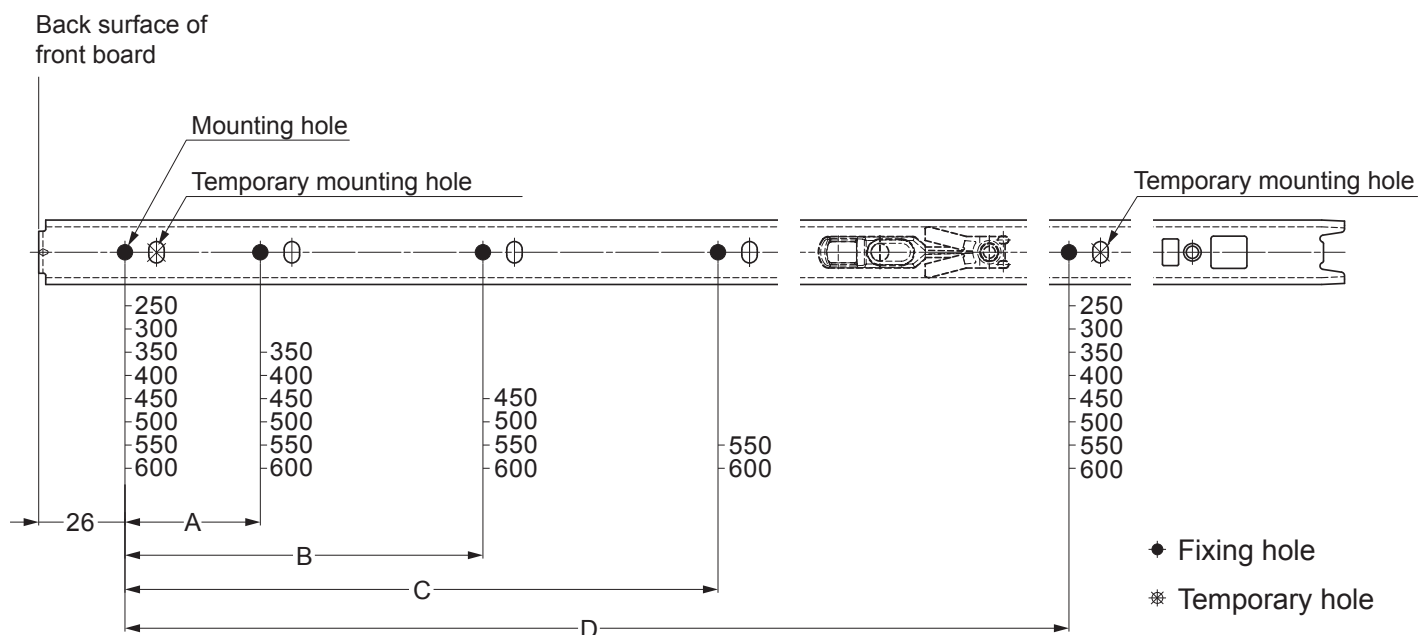

- [1] Fit the inner member to the side of the drawer, either on or just below the center line for optimum stability.
- [2] Level up and fix using the temporary mounting holes and tighten screws to fixing holes.

Notes:

- Refer to page 1 about the dimensions A to D.

### 4 Insert Drawer to Cabinet

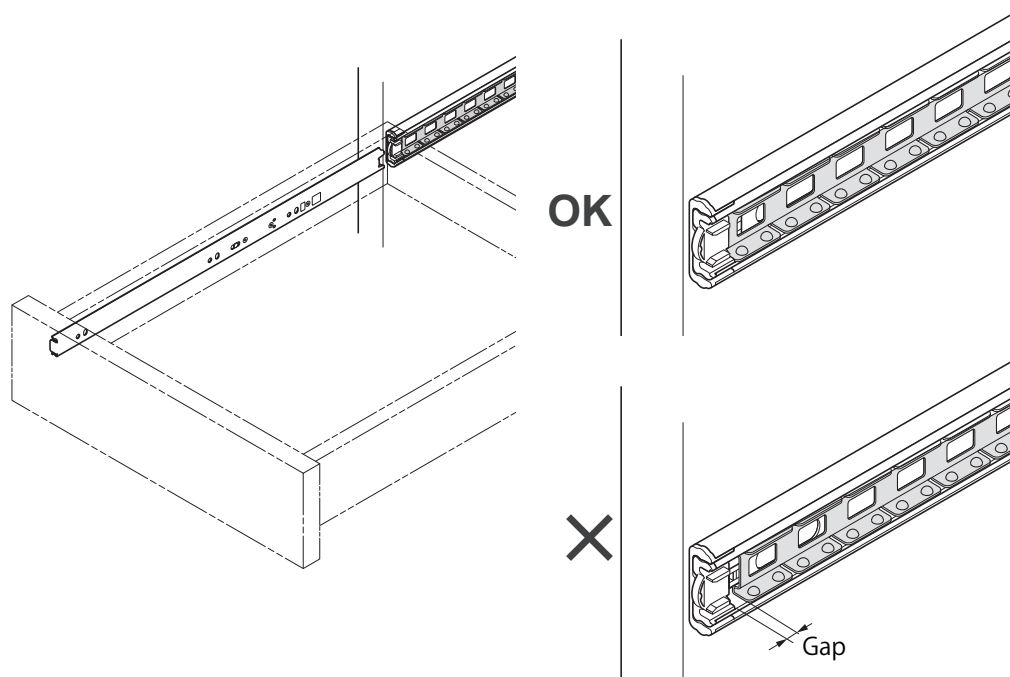

- [1] Position ball retainers to the front end.
- [2] Insert inner members of drawer to the retainers.
- [3] Check slide movement and soft-close motion if it works properly, then make adjustments if necessary.
- [4] Fix all screws on all of the slide members.

**SUGATSUNE KOGYO CO.,LTD**  
Tokyo, JAPAN  
Phone: +81 (0)3 3866 2260 E-mail:export@sugatsune.co.jp

**SUGATSUNE KOGYO (UK) LTD**  
Reading, UK  
Phone: +44 118 9272 955 E-mail:sales@sugatsune.co.uk

**SUGATSUNE EUROPE GmbH**  
Düsseldorf, GERMANY  
Phone: +49 211 53812900 E-mail:sales@sugatsune.eu

**SUGATSUNE SHANGHAI Co., LTD**  
Shanghai, CHINA  
Phone: +86 21 3632 1858 E-mail:lamp@sugatsune.com.cn

**Guangzhou, CHINA**  
Phone: +86 20 6639 3552 E-mail:lamp@sugatsune.com.cn

**SUGATSUNE KOGYO INDIA PRIVATE LIMITED**  
Mumbai, INDIA  
Phone: +91 22 28314490/91 E-mail:sales@sugatsune.in

**SUGATSUNE AMERICA, INC**  
California, USA  
Phone: +1 310 329 6373 E-mail:sales@sugatsune.com

**Chicago, USA**  
Phone: +1 312 461 1081 E-mail:chicagoshowroom@sugatsune.com.

**SUGATSUNE CANADA, INC.**  
Phone: +1 514 312 5267 E-mail:support@sugatsune.ca